

S6

Screen and blind
for windows



centor





The retractable screen is simply rolled away when not needed.

The Centor S6 is an aluminium system for insect screens or blinds up to 1800mm high and 2400mm wide. The vertically retractable, chain-operated system is easily controlled with one hand.

For use with windows

S6 can be paired alongside many window types, including sliding and louvre. The unobtrusive system is simply rolled away when not needed, keeping views to the outside clear and allowing windows to be easily cleaned.

Nest two S6 Screens together to create a duo solution – try insect mesh in one and a blackout shade in the other.

	Insect screen	Sun filter blind	Blockout blind
Frame height	300 - 1800mm		
Frame width	500 - 2400mm	500 - 2400mm	500 - 1800mm

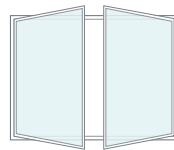

Casement

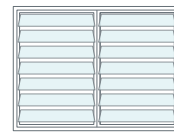

Louvre

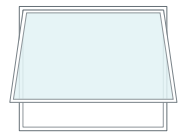

Awning

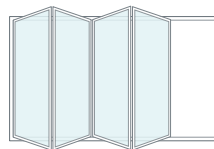

Folding



Double-hung

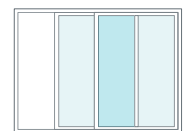

Sliding

Fabric options

S6 has the option of an insect screen or blind.

The screen mesh is constructed of long-lasting fibreglass.

Blinds are available in Sun filter, made from fibreglass/PVC, to match Centor S1 or Blockout and Light-filter, made from polyester.

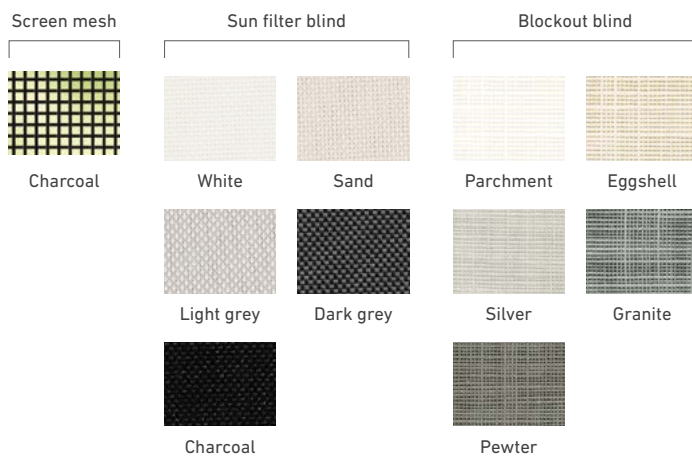

Frame options

S6 is available as standard in matt black and pearl white powder-coat or natural anodised, while custom colours are available.

The screen rail is finished in a black powder-coat.

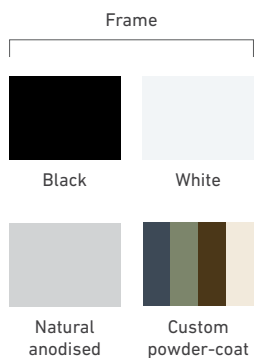

Ordering S6

S6 is ordered as a kit from Centor in selected heights and widths, ready to be cut to size.

As with all windows and doors handing is expressed when viewed from the outside, so in a left kit the ball chain is on the left when viewed from outside.

Easy assembly and installation

The S6 Screen is designed to be installed on the inside of the opening. Either fully assemble and fit to windows in your factory, or assemble and fit on-site.

Warranty

Centor offers a 5-year warranty on its S6 Screen.



Product detail

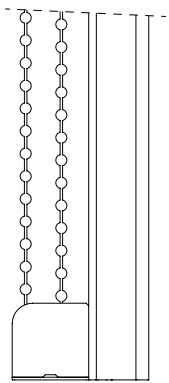
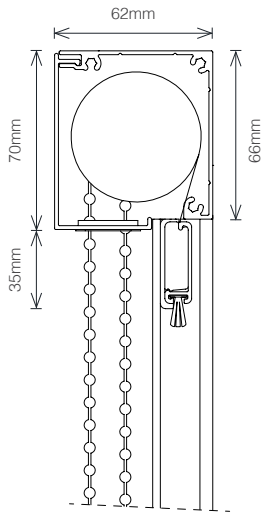
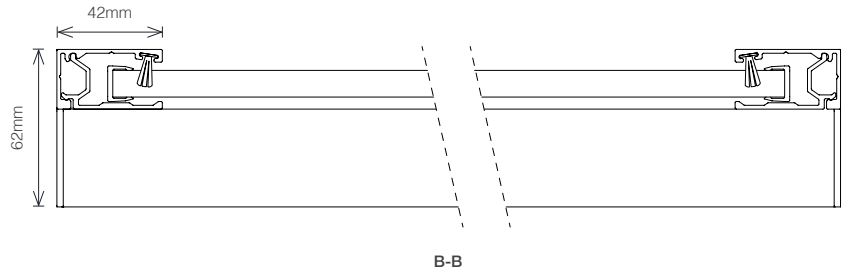

A-A

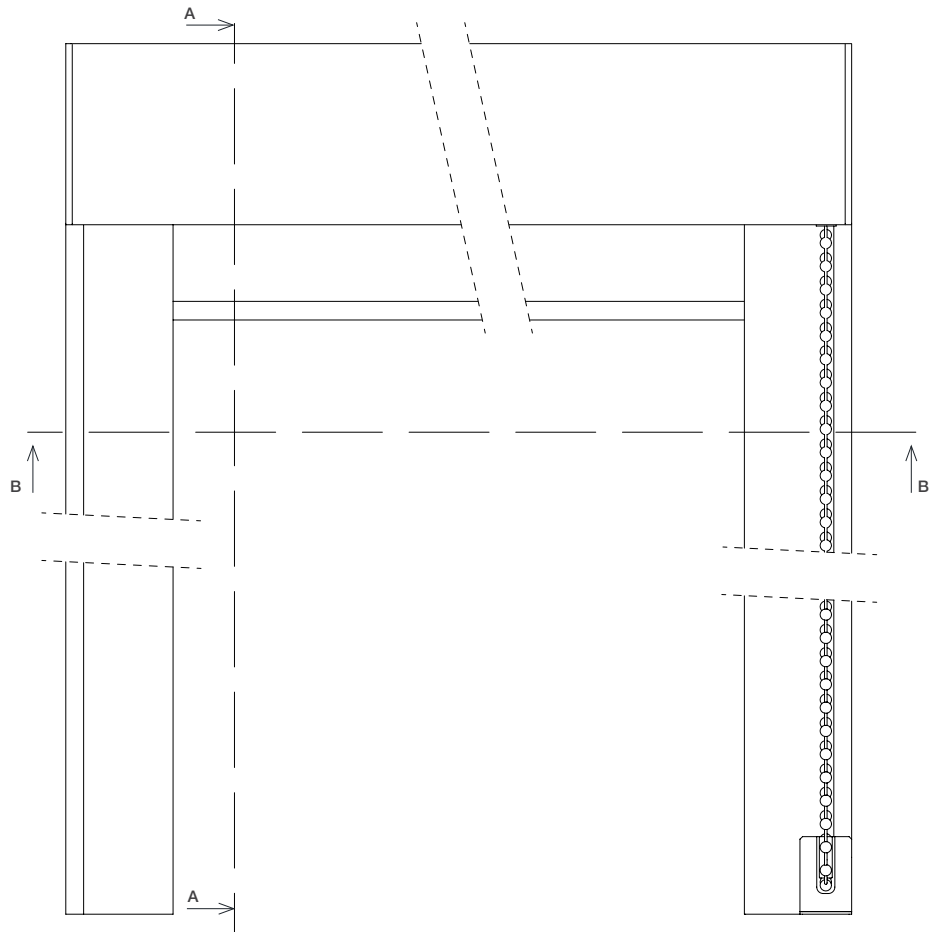

Overview

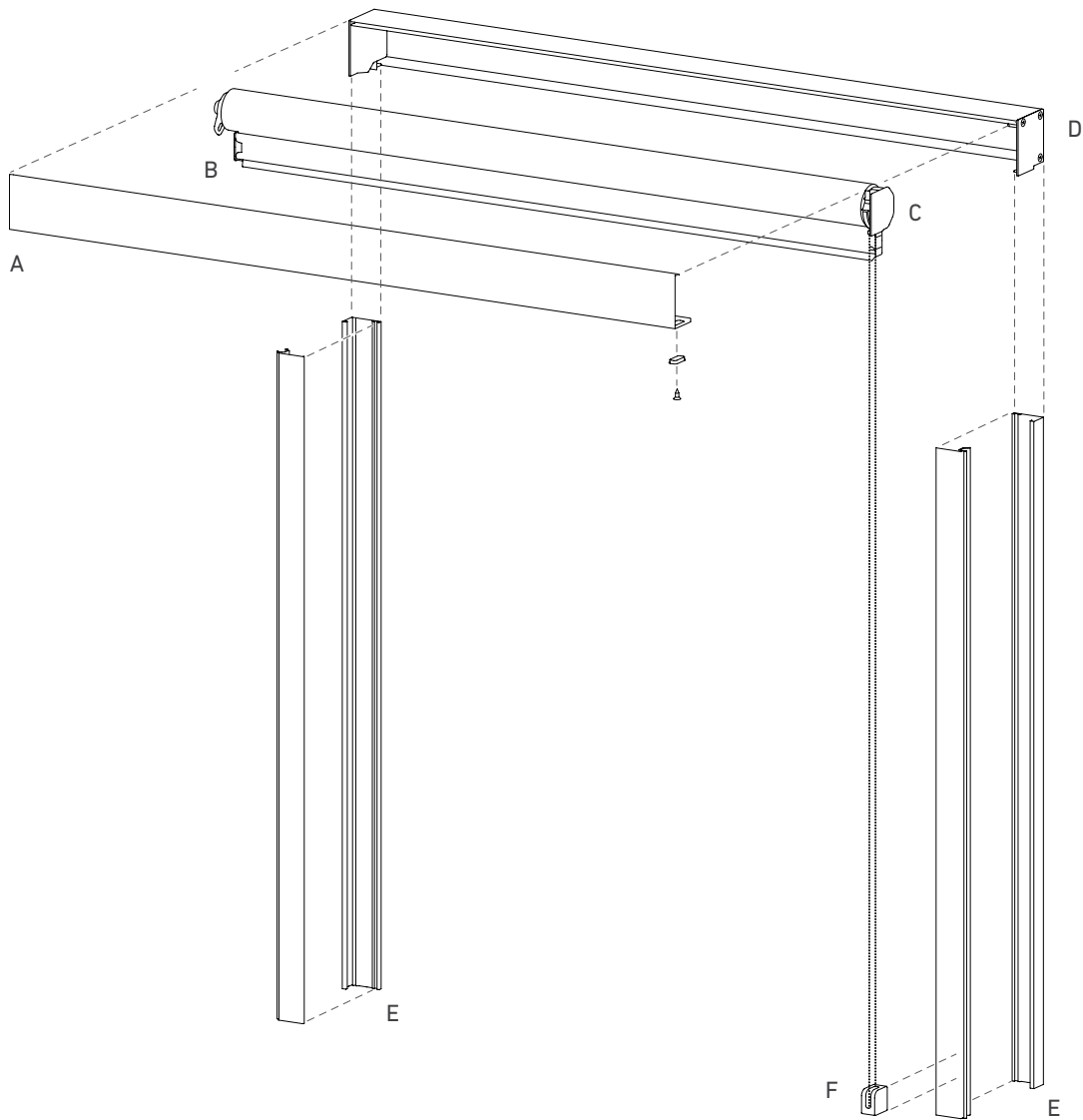

Key

- A Screen cover
- B Screen rail
- C Screen roll
- D Head
- E Screen guide
- F Ball chain

Centor Australia Pty Ltd

t 1300 CENTOR (1300 236 867)
mail@centor.com.au
centorhardware.com

BRISBANE

Centor Australia Pty Ltd
Head Office & Factory
997 Kingsford Smith Drive
PO Box 1550
Eagle Farm QLD 4009

SYDNEY

Centor Australia Pty Ltd
Unit 1/5 Merryvale Road
Minto NSW 2566

MELBOURNE

Centor Australia Pty Ltd
Suite G03/12 Corporate Drive
Moorabbin VIC 3189

ADELAIDE

Centor Australia Pty Ltd
34 Fullarton Road
Norwood SA 5067

PERTH

Centor Australia Pty Ltd
Unit 5b, 151 Herdsman Parade
Wembley WA 6014

TASMANIA

Launceston
Access Hardware Pty Ltd
12 Goodman Court
Launceston TAS 7248
t 6324 4900

Hobart

Access Hardware Pty Ltd
131 Albert Street
Hobart TAS 7000
t 6235 9000