

# *S2 retractable* **INSECT SCREEN**



The S2 Screen allows homeowners with smaller openings to enjoy the luxury of inside-outside living, insect protection, fresh air, breezes and uninterrupted views. Designed to fit nearly any door — folding, french or sliding — S2 delivers unparalleled engineering.

Operating with just a fingertip, Centor's unique load balancing technology allows screens to glide smoothly across the entire opening and effortlessly stop at any desired position.

When not in use, the screen retracts discreetly into the frame, removing visual distractions to the view outside while also protecting it from damage, dust or dirt.



### Finger-tip operation

Engineered to glide from any height



### Unobtrusive

Screens are there when needed & hidden when not



### Made to order

Custom-made to your specific requirements



### Reduce cooling needs

Screens allow breezes



## TECHNICAL BENEFITS

- Pair with smaller doors or windows, new or existing.
- Operates from any height with one hand so the youngest of family members can operate the screen.
- The screen is fully retained within the frame on two sides to allow total control of insects.
- S2 can be mounted on the inside or outside – drainage holes are added to the sill for externally mounted systems.
- Compact design – low-profile sill, just 19mm or 25mm high.
- Covers are quick and easy to remove to make servicing trouble free.

## SCREEN CONFIGURATIONS

### Single

A single screen that extends from one side of the frame and covers the full width of the opening, up to 2070mm wide.



### Double

Two screens meeting in the middle of the opening up to 4000mm wide.

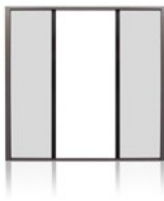

### XO

A single screen that covers a sliding door opening and stops against the door handle. The second jamb is built into the far wall. OX is also available.

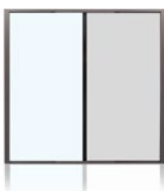

### Jambless-OX

A single screen which extends to cover the opening with no jamb against the glass corner. Pairs with corner fixed-lite windows. XO also available.

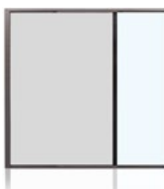

## INSECT SCREENS

Insect mesh is available in two different weave styles to suit varying environmental requirements.

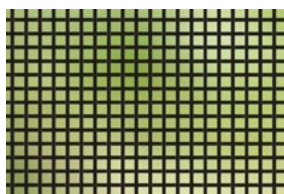

### Standard weave

Keeps insects like moths, flies & mosquitoes outside.

Openness: 46%

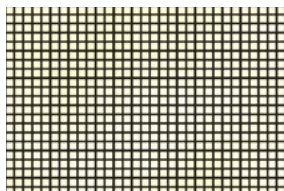

### Tight weave

Protect interiors against tiny insects like midges.

Openness: 37%

## FRAME COLOURS

S2 is constructed from durable aluminium. The frame can be powder-coated or anodised in one of our popular colours ([centor.com/screens](http://centor.com/screens)) or customised to colour match existing doors and windows.

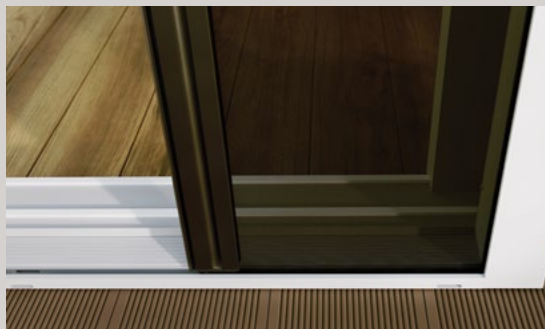

Perfect for retro-fit or new build, S2's options of 19mm or 25mm sill height allows easy alignment



Spanning up to 4m wide, S2 can be paired with most popular XO sliding and French doors



S2's slim frame delivers clean, unobtrusive lines and uninterrupted views



With the same cable system as S4, existing installers can fit both screen systems with ease.

## SIZE CONFIGURATIONS

With its slimline frame, S2 is specially designed for smaller openings.  
Pair with XO sliding, French or folding doors up to the following sizes:

max frame width

sill type	frame height	double	single 70mm jamb	single 25mm jamb	XO 70mm jamb	XO 25mm jamb	jambless
19mm sill	up to 3200mm	2550mm	1345mm	1300mm	2550mm	2505mm	-
25mm sill	up to 3200mm	4000mm	2070mm	2025mm	4000mm	3955mm	3933mm
	up to 3700mm	2550mm	1345mm	1300mm	4000mm	3955mm	3933mm
	up to 4000mm	1900mm	1020mm	975mm	4000mm	3955mm	3933mm

S2's maximum dimensions are affected by total fabric weight and screen tension. To ensure the product operates well, when the screen is wider the maximum height is reduced, and when the screen is taller the maximum width is reduced.

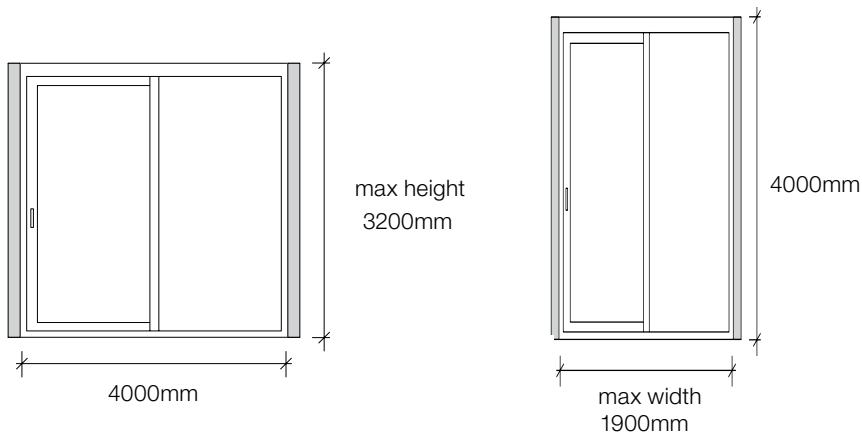

## Complementing systems



**S4 Corner Screen**

Insect screens &/or shades for post-less doors or windows



**S4 Screen & Shade**

Insect screens &/or shades for large doors or windows

S2G2-APC-APR22.03