

S5 SCREEN AND BLIND SYSTEM



Screen and blind for timber windows

centor®





SIMPLY ROLLED AWAY WHEN NOT NEEDED

Designed for timber windows up to 2400mm wide by 1800mm high, Centor's new S5 Screen is a vertically retractable, chain-operated screen or blind that can be easily controlled with one hand.

For use with windows

S5 can be paired alongside many window types.

The retractable screen or blind is simply rolled away when not needed. This makes it perfect for use on a window with a servery between the kitchen and an outdoor entertaining area. It also allows for windows to be cleaned easily.

S5 Specifications		
	frame height (min - max)	frame width (min - max)
insect screen	300 - 1800mm	500 - 2400mm
sun filter blind	300 - 1800mm	500 - 2400mm
blockout blind	300 - 1500mm	500 - 1800mm

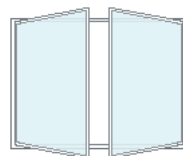

casement

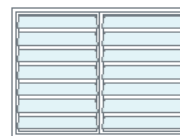

louvre



awning

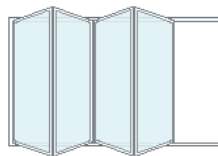

folding

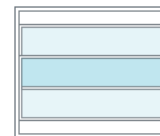

double-hung



sliding

SCREENING OPTIONS

S5 has the option of an insect screen or blind.

The screen mesh is constructed of long-lasting fibreglass.

Blinds are available in Sun filter, made from fibreglass/PVC, to match Centor S4, Blockout, made from polyester/cationic polyester.

Screen mesh

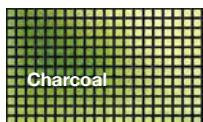

Sun filter blind

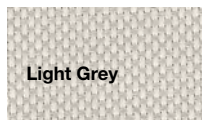
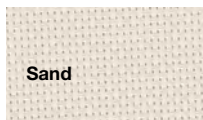
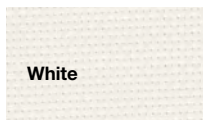

Block Out Blind

Mercury

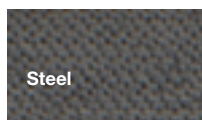
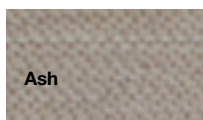
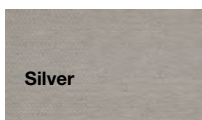
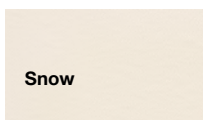
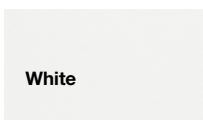

FRAME OPTIONS

S5 is available in a range of unfinished timber species or primed. The kits are also available without timber should you wish to supply your own. The head and screen guides are available in durable natural or black anodised aluminium.

The screen rail is finished in black powder-coat

Frame



Guides

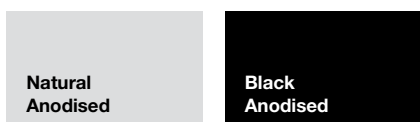

ORDERING S5

S5 is ordered as a kit from Centor in selected heights and widths, ready to be cut to size.

As with all windows and doors handing is expressed when viewed from the outside, so in a left kit the operating cord is on the left when viewed from outside.

NOTE: A LEFT HAND kit when viewed from INSIDE the building would have the cord on the right hand side.

EASY ASSEMBLY AND INSTALLATION

S5 can be either fully assembled and fitted to windows in your factory or assembled and fitted on site. In either scenario installation couldn't be easier using the comprehensive instructions provided.

WARRANTY

Centor offers a 5-year warranty on its S5 Screen.



S5 PRODUCT DETAILS

Downloadable DXF or DWG files ready for use in your own documentation are a convenient resource for architects and specifiers wishing to use Centor systems.

S5 DXF or DWG files can be downloaded from centor.com

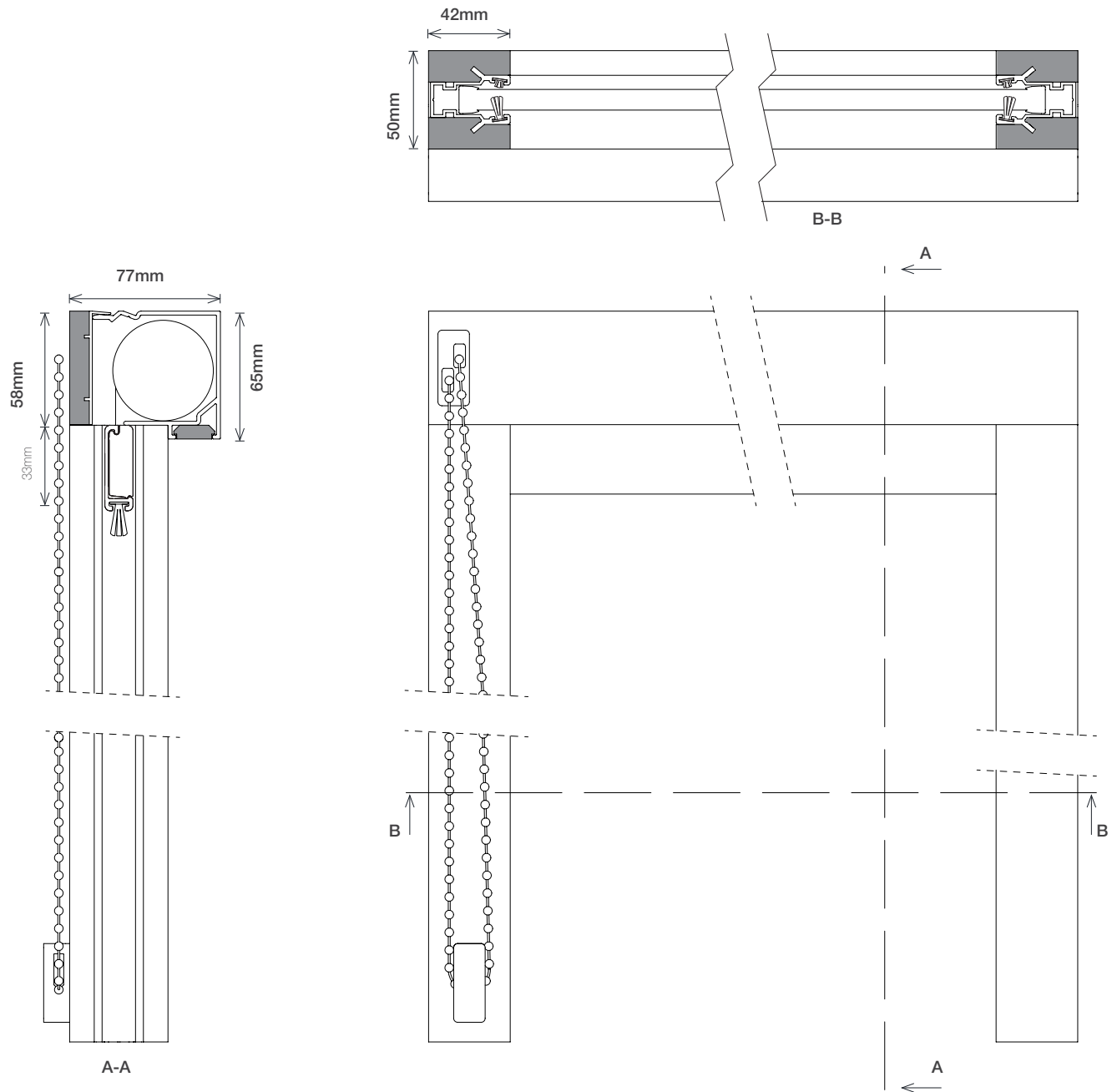

OVERVIEW

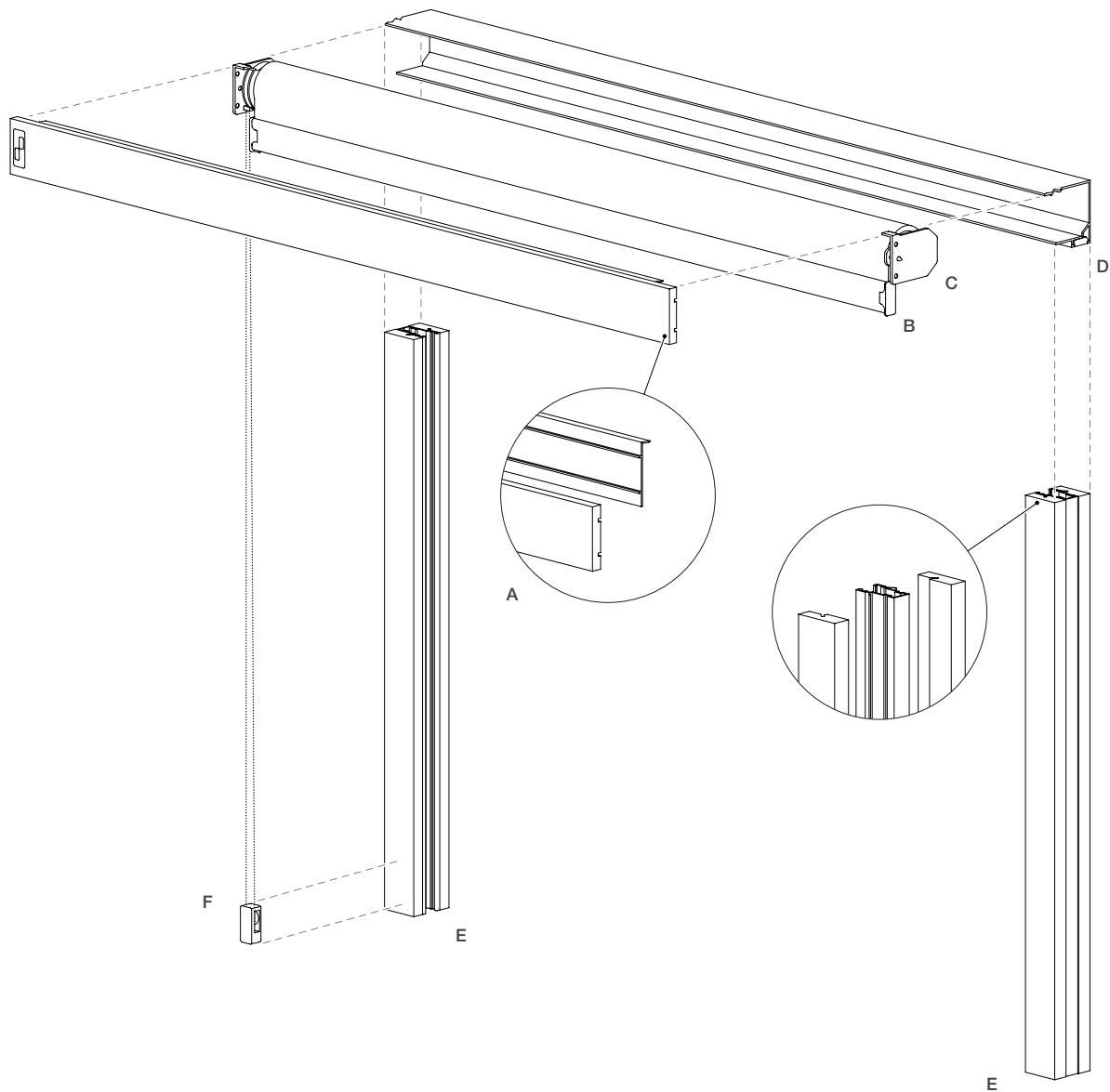

Key

- A Screen cover
- B Screen rail
- C Screen roll
- D Head
- E Screen guide
- F Ball chain

Centor Australia Pty Ltd

1300 CENTOR (1300 236 867)

+61 7 3868 5777

mail@centor.com.au

centor.com

