

S6 SCREEN & SHADE SYSTEM



Screen and shade for windows

centor®

*Simply
roll away
when not
needed*



The Centor S6 is an aluminium system for insect screens or shades up to 70 ⁷/₈" high and 94 ¹/₂" wide. The vertically retractable, chain-operated system is easily controlled with one hand.

	Frame height (min - max)	Frame width (min - max)
insect screen	11 ¹³ / ₁₆ " - 70 ⁷ / ₈ "	19 ¹³ / ₁₆ " - 94 ¹ / ₂ "
sun filter shade	11 ¹³ / ₁₆ " - 70 ⁷ / ₈ "	19 ¹³ / ₁₆ " - 94 ¹ / ₂ "
blockout shade	11 ¹³ / ₁₆ " - 70 ⁷ / ₈ "	19 ¹³ / ₁₆ " - 70 ⁷ / ₈ "



For use with windows

S6 can be paired alongside many window types, including sliding and casement. The unobtrusive system is simply rolled away when not needed, keeping views to the outside clear and allowing windows to be easily cleaned.

Nest two S6 Screens together to create a duo solution - insect mesh in one and a blockout shade in the other.

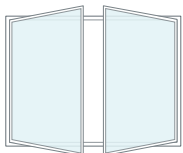

casement

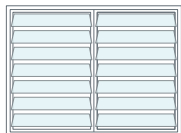

louvre



awning

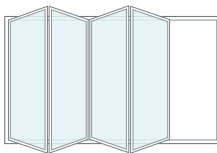

folding

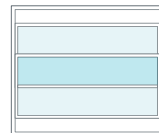

double-hung

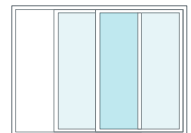

sliding

SCREENING OPTIONS

S6 has the option of an insect screen or shade.

The screen mesh is constructed of long-lasting fibreglass.

Shades are available in Light-Filtering or Blockout, made from polyester.

Screen mesh

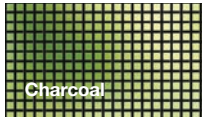

Light-Filtering shade – Mercury

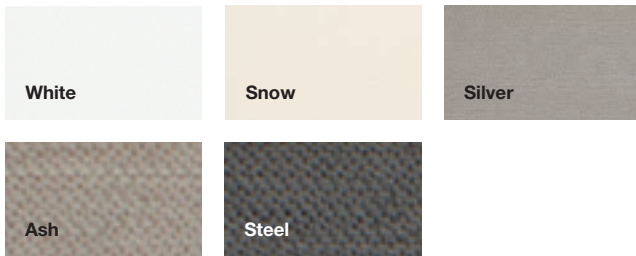

Blockout shade – Mercury

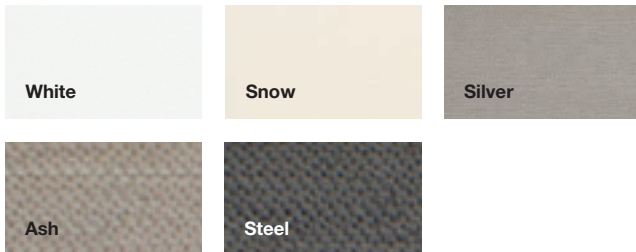

FRAME OPTIONS

S6 is available as standard in natural anodised, while custom colors are available.

The screen rail is finished in a black powder-coat.

Frame



ORDERING S6

S6 is ordered as a kit from Centor in selected heights and widths, ready to be cut to size.

Handing is expressed when viewed from the outside; so in a left kit the operating cord is on the left when viewed from outside.

NOTE: A LEFT HAND kit when viewed from INSIDE the building would have the cord on the right hand side.

EASY ASSEMBLY AND INSTALLATION

The S6 Screen is designed to be installed on the inside of the opening. Either fully assemble and fit to windows in your factory, or assemble and fit on-site.

WARRANTY

Centor offers a 5-year warranty on its S6 Screen.



S6 PRODUCT DETAILS

Downloadable DXF or DWG files ready for use in your own documentation are a convenient resource for architects and specifiers wishing to use Centor systems.

S6 DXF or DWG files can be downloaded from centor.com

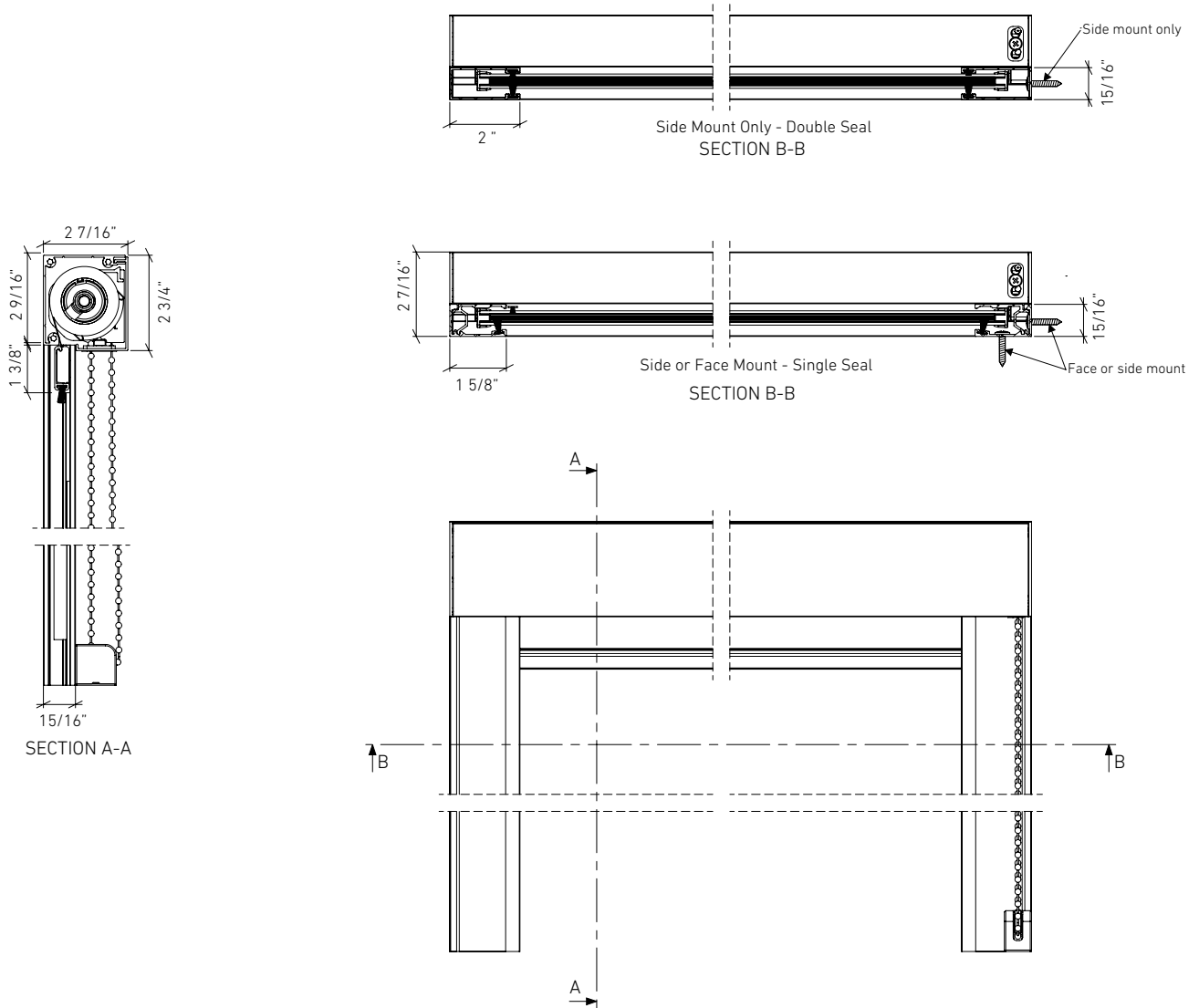

OVERVIEW

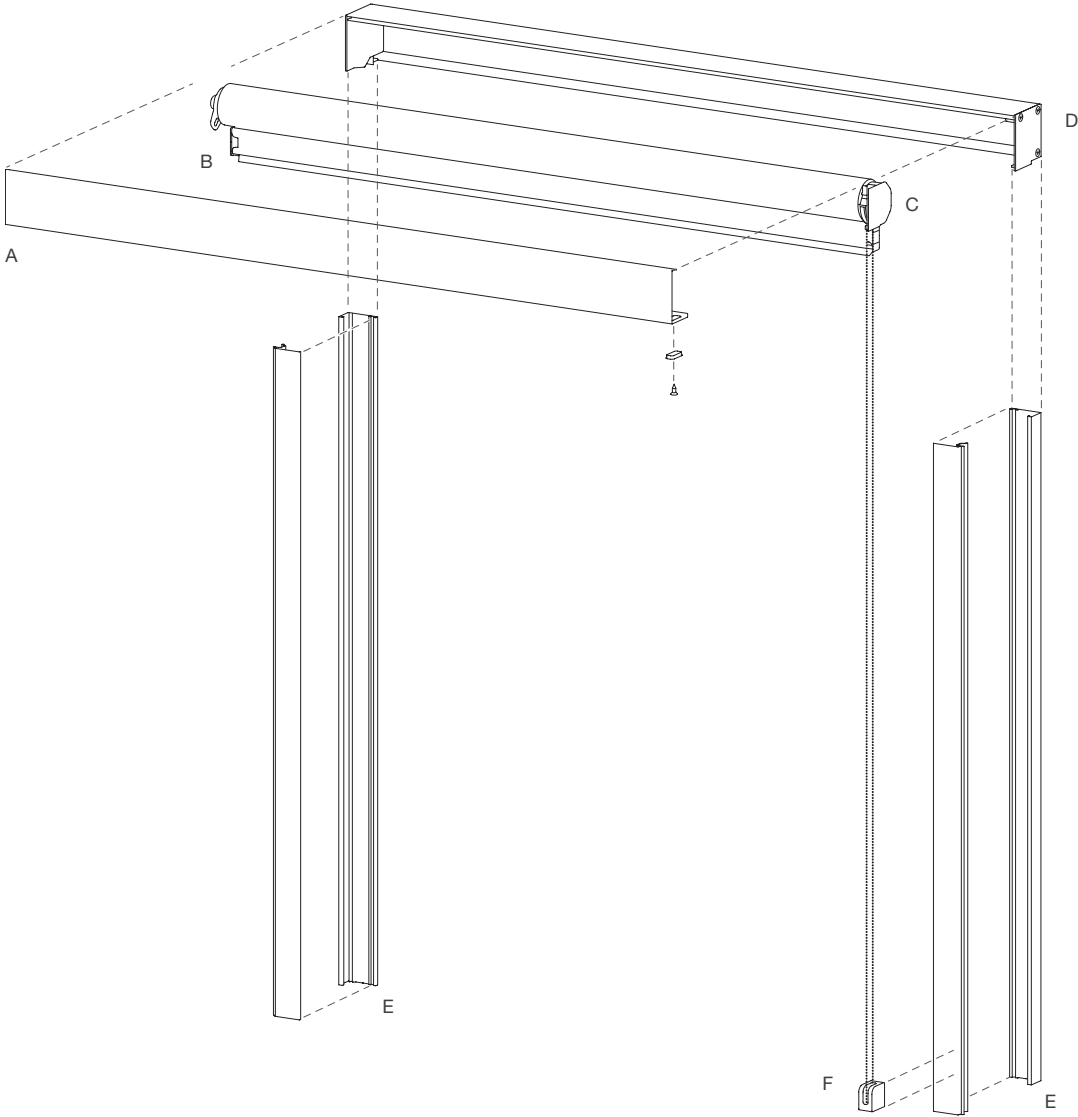

- Key**
- A Screen cover
 - B Screen rail
 - C Screen roll
 - D Head
 - E Screen guide
 - F Ball chain

Centor North America Inc

966-130 Corporate Blvd

Aurora, IL 60502

Toll free (inside US) 866-255-0008

t +1 630-957-1000

customerserviceusa@centor.com

centor.com

